

FUSION IQ[®]

OPERATOR'S MANUAL



STAHL'S
Hotronix[®]

When using your heat press, basic precautions should always be followed, including the following:

1. Read all instructions.
2. Use heat press only for its intended use.
3. To reduce the risk of electric shock, do not immerse the heat press in water or other liquids.
4. Never pull cord to disconnect from outlet, instead grasp plug and pull to disconnect.
5. Do not allow cord to touch hot surfaces, allow heat press to cool completely before storing.
6. Do not operate heat press with a damaged cord or if the equipment has been dropped or damaged. To reduce the risk of electric shock, do not disassemble or attempt to repair the heat press. Take it to a qualified service person for examination and repair. Incorrect assembly or repair could increase the risk of fire, electric shock, or injury to persons when the equipment is used. Power supply cord must be disconnected before cleaning or servicing press.
7. This appliance is not intended for use by persons (including children) with reduced physical, sensory or mental capabilities, or lack of experience and knowledge, unless they have been given supervision or instruction concerning use of the appliance by a person responsible for their safety.
8. Close supervision is necessary for any heat press being used by or near children. Do not leave equipment unattended while connected.
9. To avoid burns, do not touch hot metal parts or the heated platen during use.
10. To reduce the likelihood of circuit overload, do not operate other high voltage equipment on the same circuit.
11. If an extension cord is necessary, then a 20-ampere rated cord should be used. Cords rated for less ampere may overheat. Care should be taken to arrange the cord so that it cannot be pulled or tripped over.
12. Keep hands clear of the upper heat press platen during lock down as the pressure may cause injury.
13. Heat press should be placed on a sturdy, suitable stand at least 36"L x 24"W x 29"H.
14. Work area must be kept clean, tidy and free of obstructions.

Table Of Contents



Safety Instructions 2

Machine View 4

Operating Instructions 5-7

Connecting the System 5

Start Up/Shut Down 5

Home Screen 6

Prepare to Print 7

Touch Screen Guide 8-11

Setup Menu 8

Password Setup 8

Preset Setup 9

Date & Time Setup 10

Display Setup 10

Auto On & Off Setup 10

System Setup 10

Calibration 11

Updating Software 11

Connecting to the IQ® Portal 12

Electrical Schematic 13

Replacement Parts List 14-15

Contact 16

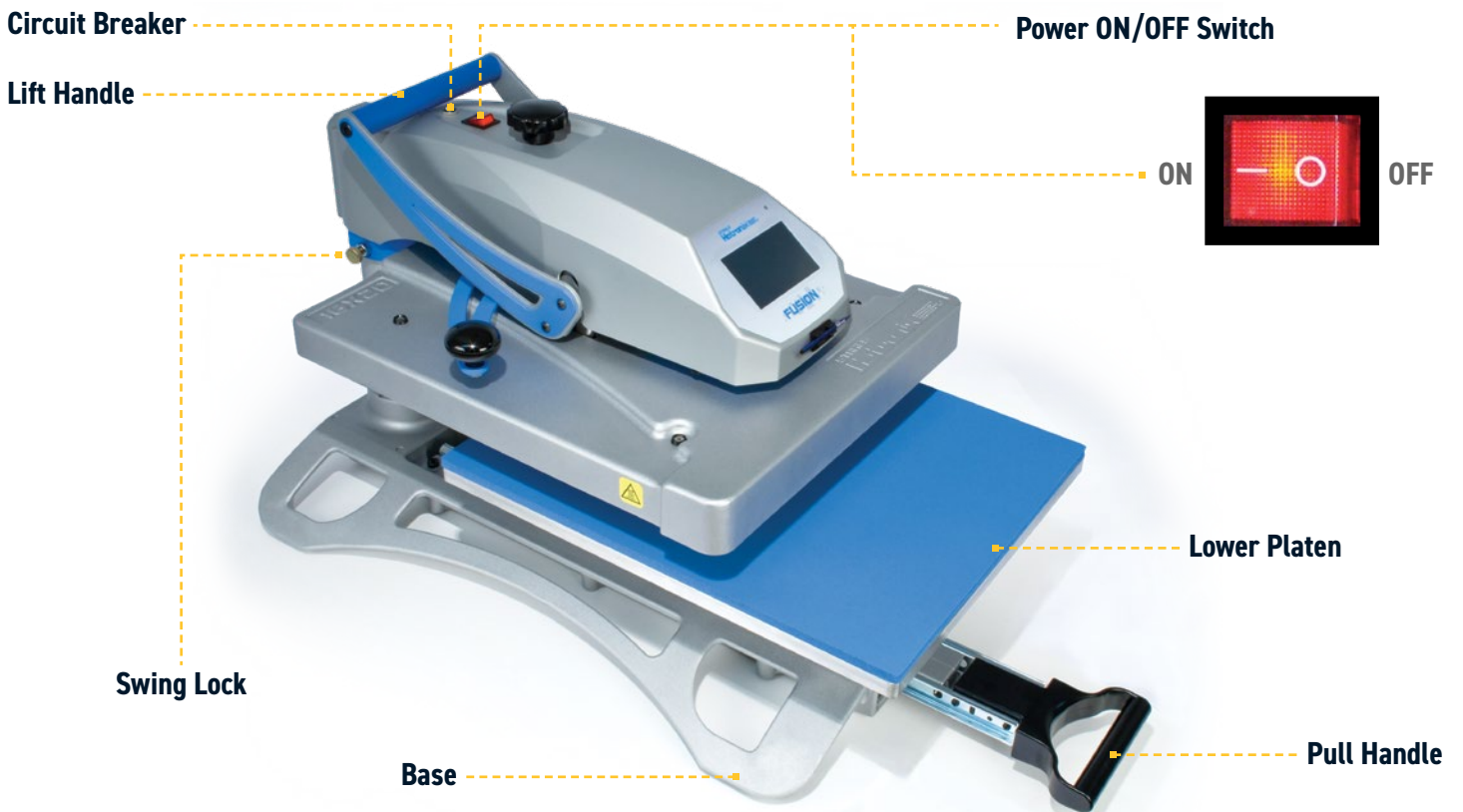

Operating Instructions

Connecting the System

Insert power cord into IEC inlet located in the back of the press (1.1).

Connect the power cord into a properly grounded electrical outlet with a sufficient amperage rating.

NOTE: To release power cord from press, hold two red buttons on both sides of cord and pull (1.2).

Voltage

120 volt requires a full 20-amp grounded circuit for 120-volt operation.

220 volt requires a full 10-amp grounded circuit for 220-volt operation.

Start Up/Shut Down

To start up your heat press:

Flip the power switch ON (2.1). A splash screen displaying the Hotronix® logo and current software version is shown for several seconds.

To turn your heat press off, flip the power switch OFF.

To place your heat press into Standby Mode, touch and release the Power icon on the Home Screen (3.2). In Standby Mode, the heater turns off while the Touch Screen remains on, displaying an orange background as a warning if the platen is still hot (above 100°F / 38°C).

NOTE: Standby Mode must be used for the Auto On feature to function (10.1). The Auto On feature will not work if the power switch (2.1) is in the OFF position.

To start up your heat press while in Standby Mode, touch and release the Home icon on the Standby Screen.



1.1



1.2



2.1



Home Screen

Displays the selected preset. Touch and hold to see application settings.

NOTE: Holding down material name will display targeted application settings. Screen displays current temperature, pressure, and time.

Displays multiple heat application preset step. Touch the empty circled numbers to switch between preset steps.

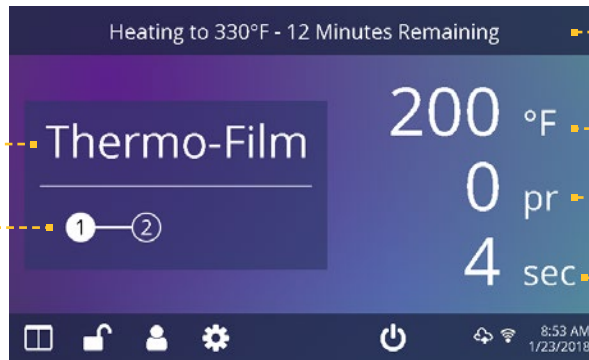

3.1

Status bar provides helpful information regarding heat press.

Displays the current application temperature and time. To view pressure, touch 0 and target pressure is displayed. Manual pressure adjustment required.

Touch and edit your favorite presets.

Lock the screen (Manager-level only) to prevent User-level operators from changing settings.

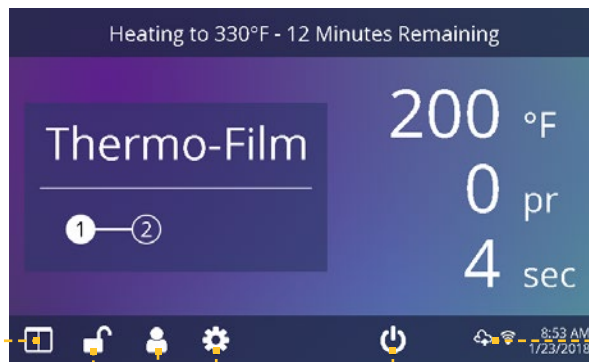

3.2

IQ® Portal and WIFI connection status.

Touch and edit Users to control operator access level and track press usage by operator in the IQ® Portal.

Touch Setup menu.

Place press in Standby Mode to take advantage of the scheduled Auto On feature.

Prepare to Print

To begin heat applying, start by verifying that you have the proper settings displayed on the Home Screen.

- Select preset material application.
- Manually enter temperature and time for selected material. Adjust pressure accordingly.

When desired settings are reached, you can begin heat application.

When using the Swing feature (4.1), release Swing Lock first, then swing the heat platen outward and position the garment and design.

When using the Draw feature (4.2), pull out the lower platen and position the garment and design.

Swing or push the platen back into position and lower platen to heat apply.

The Home Screen will initiate a count down and signal when to lift the platen off the garment.

Swing or pull the heat platen and proceed according to the application instructions.



4.1



4.2



Setup Menu

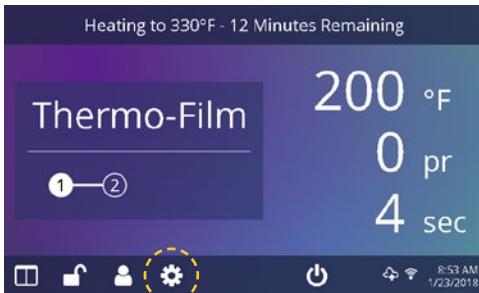

5.1

Touch the Settings icon on the Home Screen (5.1) to configure your heat press.

Managers can access all setup options, while Users can access a limited set (5.2).

- Managers default password: M



5.2

Password Setup (Manager Level Only)

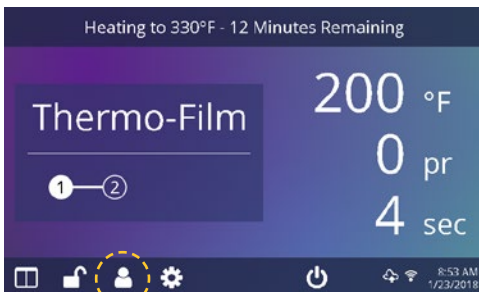

6.1

Touch the User icon on the Home Screen (6.1) or Setup Menu (6.2) to select, add, and edit Users.

Touch and edit Managers and Users to configure access to settings (6.3, 6.4). Heat press reports on the IQ® Portal can be filtered by User to track individual operator performance.

Touch the arrow keys on the taskbar to scroll through a long list of Users (6.5).



6.2

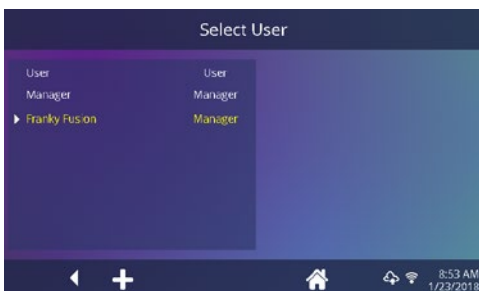

6.3

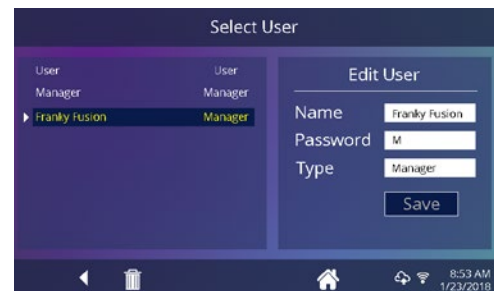

6.4

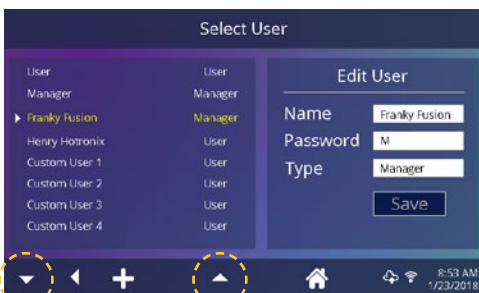

6.5

Preset Setup

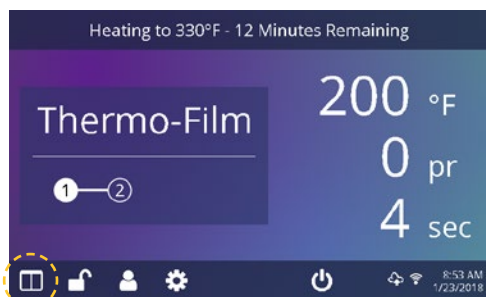

7.1

Touch the Columns icon (7.1) to select from a list of saved presets (7.2).

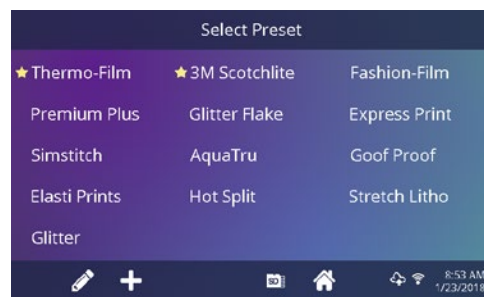

7.2

Touch the arrow keys on the taskbar to scroll through a long list of presets (7.3).

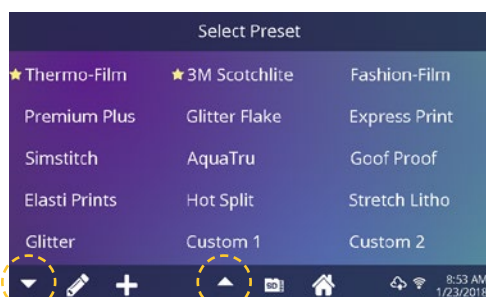

7.3

Touch a preset to select a material.

Touch the Pencil icon (7.4) to enter edit mode, then touch preset name to edit settings. Touch Enter to save changes.

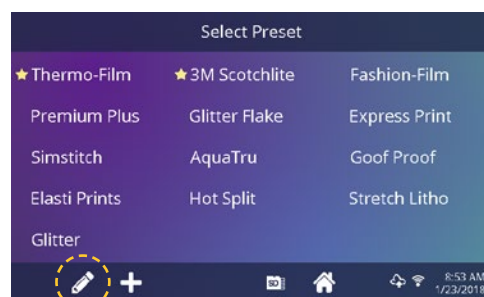

7.4

Touch the Plus icon to create a new preset (7.5).

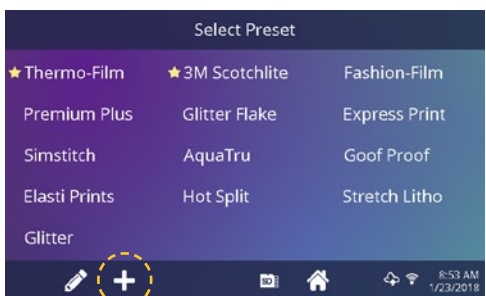

7.5

Name your preset and enter desired temperature, time, and pressure. When creating a new preset, the current Home Screen application settings are selected automatically (7.6).



7.6

Touch the empty circled numbers to set multiple preset stages for pretreatment or multi-step applications (7.7).

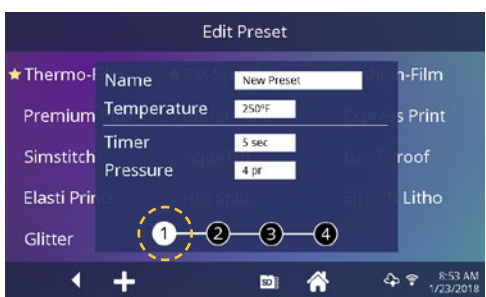

7.7

Date & Time Setup

Touch the Settings icon on the Home Screen.

- Touch Date & Time, information displays on right of screen (8.1).
- Touch up/down arrows to select time zone.
- Touch Auto to automatically synchronize the heat press clock.
The heat press must be connected to a WIFI network with access to the Internet.
- Touch Daylight Saving to enable daylight saving mode.
This option should be enabled during summer.

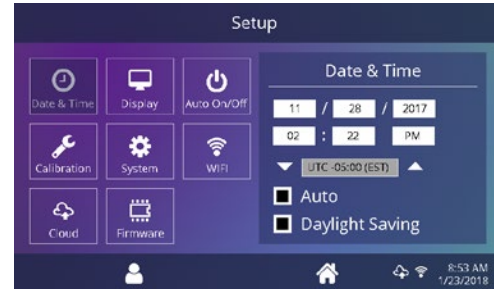

8.1

Display Setup

Touch the Settings icon on the Home Screen.

- Touch Display, information displays on right of screen (9.1).
- Touch Temperature to switch between F° or C°, then touch Check Mark icon on taskbar to save.



9.1

Auto On & Off Setup

Touch the Settings icon on the Home Screen.

- Touch Auto On/Off, information displays on right of screen (10.1).
- Touch Enable, then On Hour/Minute and Off Hour/Minute, selecting Enter between each setting. Once entered, touch Check Mark icon on taskbar to save.

NOTE: Standby Mode must be used for the Auto On feature to function (3.2).
The Auto On feature will not work if the power switch (2.1) is in the OFF position.

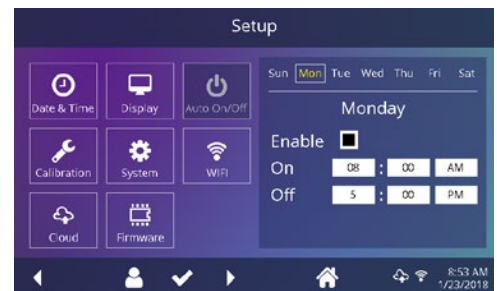

10.1

System Setup (Manager Level Only)

Touch the Settings icon on the Home Screen.

- Select System, information displays on right of screen (11.1).
- Touch Power Save and select time, then touch Check Mark icon on taskbar to save.
- When enabled, your heat press will enter Standby Mode if it is not used for the specified number of hours.

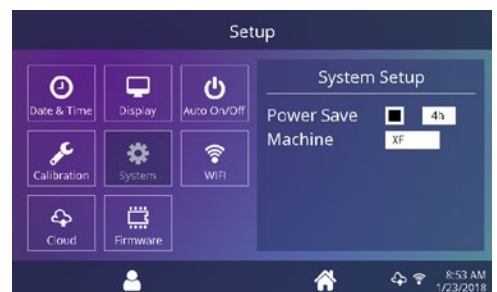

11.1

Calibration (Manager Level Only)

Your heat press comes pre-calibrated from the factory. Calibration is only required after sensor or controller replacement. Pressure is periodically self-calibrated. Incorrect calibration can result in poor print results or damage to your heat press which is not covered by warranty.

All FUSION® heat presses have a temperature calibration function (12.1).

- Turn on heat press and heat to 350°F/177°C.
- Place temperature strip on center of platen and press for 5 seconds, or measure center of heater with contact thermocouple (not infrared) thermometer.
- Touch the Settings icon on the Home Screen.
- Touch Calibration, information displays on right of screen.
- Touch Temperature and adjust Temperature Calibration to match Target Temperature.

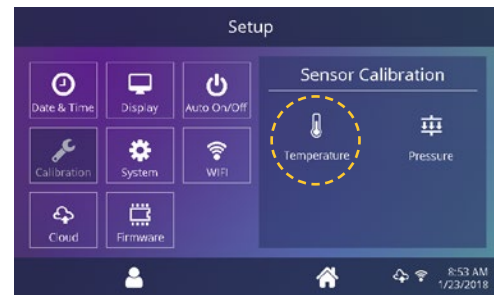

12.1

Manual FUSION® heat presses have a pressure calibration function (12.2).

- Touch the Settings icon on the Home Screen.
- Touch Calibration, information displays on the right of screen.
- Touch Pressure and then Calibrate. Wait for the screen to display 2.5V.
- Adjust pressure knob until reading is 2.7V (with handle lowered in print position), then touch Set Min Point.
- Adjust pressure knob 1 turn clockwise, then lower handle into print position (reading should be 3.1V or 3.2V), then touch Set Max Point.

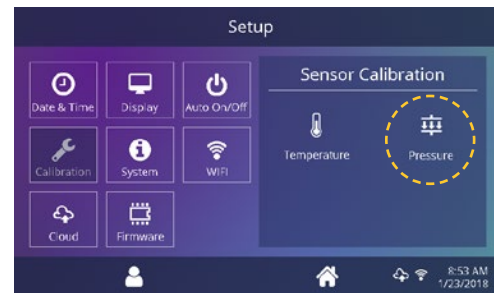

12.2

Updating Software

Touch the Settings icon on the Home Screen.

- When a software update is available, an exclamation point appears after the version number in the Setup Menu (5.2).
- Touch Firmware, information displays on right of screen. An available online update displays a cloud icon.
- Touch Update File on right of screen, then touch Check Mark icon on taskbar to start download. A downloaded update displays a memory card icon.
- Touch Downloaded Update File on right of screen, then touch Check Mark icon on taskbar to start installation.

NOTE: If a power failure occurs during installation, the heat press will attempt to install the previous software version.



Create Your Account

- Using a phone or computer, visit iq.hotronix.com to create an account (13.1).
- Enter your name, email, and password.
- Click on the confirmation link in the email you receive.
- Your account has been created.

Register a Heat Press

- Click on Manage Heat Presses, then New Heat Press.
- Select heat press type, enter serial number, and enter a name for the heat press (optional).
- Click on Create Heat Press and enter the verification code given.
- On the heat press Setup Menu, touch WIFI and connect to your WIFI router or mobile hotspot (13.2).
- On the heat press Setup Menu, touch the Cloud icon and enter the verification code displayed in the IQ® Portal (13.3).
- Your heat press has been registered.

Create & Assign Users

- Click on Manage Operators, then New User.
- Enter a name and select a privilege level. Managers can access all heat press settings while Users have limited access.
- Click on New User, then Assign Machines in the sidebar.
- Select a machine and click Assign.
- On the heat press Setup Menu, touch the Cloud icon, then Manual Sync (13.4).
- Reporting will show impressions made by the Users.

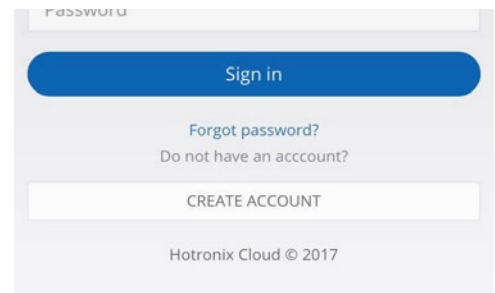

13.1



13.2

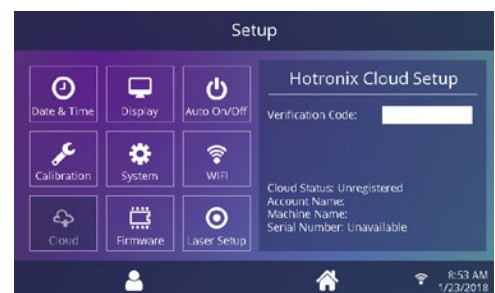

13.3

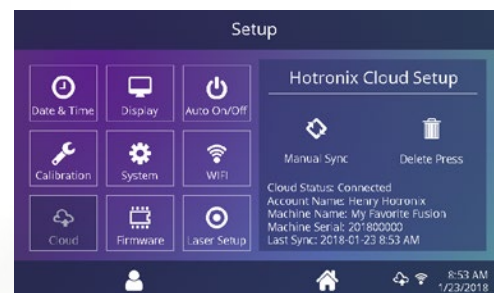

13.4



Electrical Schematic

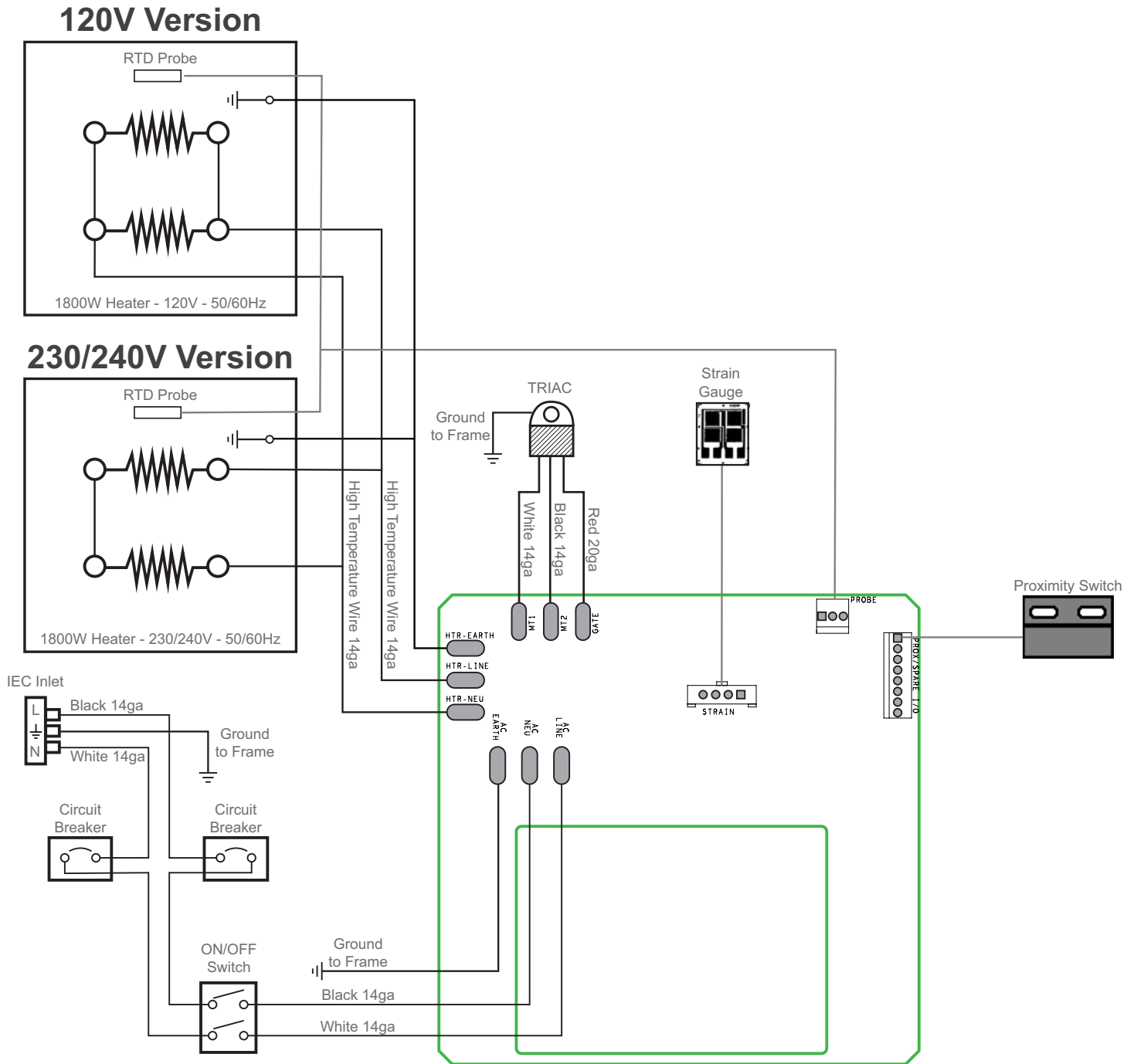

ITEM #	PART NAME	PART #	QTY
1	120V Locking Power Cord	2-1671	1
2	Fusion IQ Controller	1-2463	1
3	Fusion Overlay NextGen	1-2198-1	1
4	Fusion Control Housing	1-2197	2
5	Fusion IQ Power Board	—	1
6	Fusion IQ Power Bracket	1-2473	2
7	Screw, Sheet Metal #6 x 1/2"	3-1011-235	2
8	Fusion IQ Latch	1-2474	1
9	Spring, 1/4" x 1", 1.7lbs/in	1-2485	3
10	Power Switch	1-2087	2
11	Power Inlet	1-1759	1
12	Screw, Machine #6-32 x 1/2"	3-1011-19	1
13	Nut, #6-32 Hex with Lockwasher	2-1006-50	1
14	Touchscreen Stylus Holder	1-2386	1
15	Touchscreen Stylus	1-2385	1
16	Circuit Breaker 20A (STX XF XRF)	1-1331	1
17	Thumbscrew #8-32 x 17/32"	1-2200	2
19	Fusion Inner Lift Arm (Silver, Thick)	1-2207	2
20	Fusion Outer Lift Arm (Thin Blue)	1-2208	2
21	Screw, Button Socket Head 1/4"-20 X 5/8"	3-1011-241	8
23	Fusion Bearing Cap	1-1301	4
24	Screw, Shoulder 3/8" x 1-1/4" w/ 5/16"-18 Thread	3-1011-55	2
25	Washer, 3/8" SAE Narrow	2-1006-46	6
26	Nut, Hex Nylok 5/16"-18	2-1006-20	2
28	Fusion Handle Spacer	1-2434	1
29	Foam Grip Blue 8"	1-2116	1
30	Screw, Socket Button Head, 3/8-16 X 3/4"	3-1011-244	3
31	Proximity Magnet (Modified)	1-1219	1
32	Magnet, Neodymium 0.75 x 0.125 w/ #8 Countersink	1-2414	1
33	Machine Screw Countersunk Phillips 8-32 x 0.3125	1-2413	1
34	Fusion Adjustment Spindle	1-1010-2	1
35	Washer, Spherical 5/8"	2-1006-92	1
36	Shim, Steel, 5/8" ID 1" OD 1/8" Thick	1-2217	1
37	Adjustment Knob	1-1012	1
38	E-Clip 1/2" Shaft	1-1019-1	1
39	Fusion Adjustment Casting	Kit 3-6943	1
40	Proximity Switch	1-1211	2
43	TRIAC	1-1059	1
44	Ball Plunger 3/8"-16 x 5/8"	1-2201	2
45	Screw, Machine #6-32 x 1/4"	3-1011-25	2
46	Screw, Machine #8-32 x 1/2"	3-1011-159	1
47	Nut, Hex 3/8"-16	2-1006-18	3
48	Lift Link XS & Fusion	1-1024	2
49	Fusion Upper Casting	2-1664	1
51	Upper Casting Bearing Spacer	—	1
53	Fusion Stop Collar	1-2203	1
56	Spindle Creep Plate	—	1
57	Rubber Washer, 5/8" Screw Size	1-2445	1
58	Swing Knob Black 2in Threaded	1-1054	1
59	Screw, Pan Phillips #4-40 x 1"	3-1011-130	2
60	Nut, #4-40 with Tooth Washer	2-1006-51	2

ITEM #	PART NAME	PART #	QTY
61	Standoff, #4-40 x 5/16" Aluminum 1/4" Hex	1-2073	2
62	Spring Plunger, 3/8"-16 Hand Retractable	1-2206	1
63	Steel Pin, 1/2" x 4.38"	2-1055-27	1
64	Hub Cap 1/2"	1-1107-1	2
65	Bushing, Flange 1in	1-2282	1
66	Screw, Machine #8-32 x 3/4"	3-1011-155	1
67	Nut, Hex #8-32 w/ Tooth Washer	2-1006-52	2
68	Clamp, Cable 7/16" Black	1-1105	1
69	Screw, Socket Head Cap Low Profile 1/4-20 X 3/4"	3-1011-245	2
70	Lever Nut 3 Conductor	1-2365	3
71	Heat Platen 16 x 20 1800W Manual Fusion (Ears)	2-1002	1
72	Insulation 16 x 20	1-1020	1
73	Heater Cover 16"x20" Fusion	1-2189	1
75	Fusion Guide Tube	1-2194	1
77	Pin, Clevis 3/8" x 1-3/8"	1-1017-1	2
78	Retaining Clip, Rue Ring	1-1043-2	2
79	Temperature Probe	1-1272-1	1
80	Thermostat Disc	1-2076	1
81	Screw, SS Sheet Metal #4 X 1/4"	3-1011-98	4
82	Screw, SS Phillips #8-32 X 1/4"	3-1011-87	1
83	Washer, Plastic Finishing	1-1063	4
84	Screw, Flat Head Phillips #10-24 x 7/16"	3-1011-217	4
85	Adapter Harness (Not Shown)	1-2318	1
86	Platen, 16x20	2-1029	1
87	Silicone Pad 16 x 20 Blue	1-2136	1
88	Adapter Plate	3-1336	1
89	Quick Release Pin	1-2215	1
90	Washer, Flat 1/4" SAE	2-1006-25	4
91	Washer, Split Lock 1/4"	2-1006-44	4
92	Screw, Socket Head Cap 1/4"-20 x 1"	3-1011-191	4
93	Fusion Quick Release C-Frame	3-1335	1
94	Quick Release Clamp, Manual Presses	1-2332	1
95	Draw Handle	1-2182	1
96	Fusion Slide Cover	Kit 3-1294	1
98	Screw, Sheet Metal #8 x 1/2"	3-1011-108	4
99	Screw, Slotted Pan #10-24 x 1/2"	3-1011-66	6
100	Fusion Draw Hold-Out Bracket	—	1
101	Washer, #6 Stainless Oversized	2-1006-11	2
102	Magnet, Neodymium 0.50 x 0.25 w/ #6 Countersinks	1-2487	1
103	Screw, Countersunk Phillips #6-32 x 3/4" Stainless	3-1011-252	1
104	Fusion Base Casting	4-1175	1
107	Slide Rail	1-1749	2
108	Rubber Foot	1-2199-1	4
109	Fusion Stop Plate	—	1
110	Needle Bearing Inner Race	1-2261	2
111	Spindle Race Spacer	1-2433	1
112	Screw, Socket Head Cap 1/4"-28 x 3/4"	—	3
113	Screw, Countersunk Phillips #10-24 x 3/8"	3-1011-69	8
114	Magnet, Neodymium 0.625 x 0.25 w/ #6 Countersink	1-2486	1
115	Screw, Countersunk Sheet Metal #6 x 1/2" Stainless	—	1

Parts Location Guide

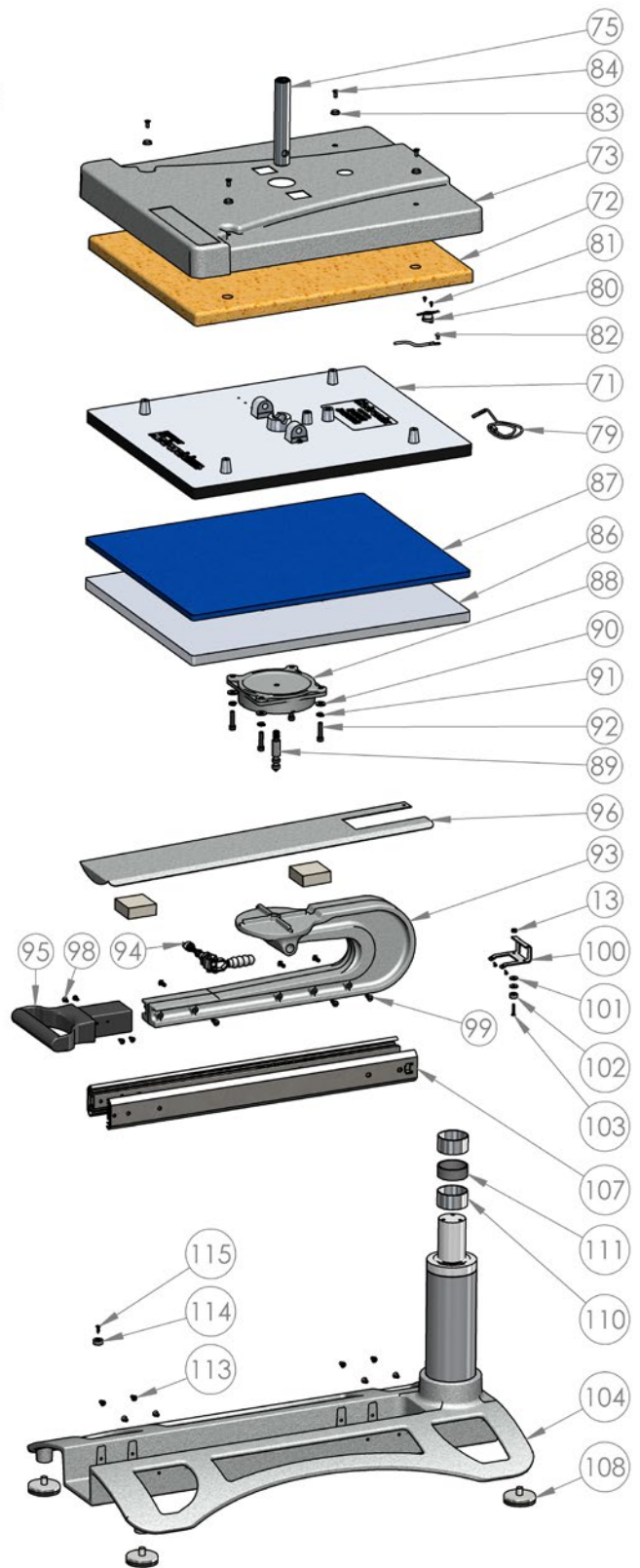
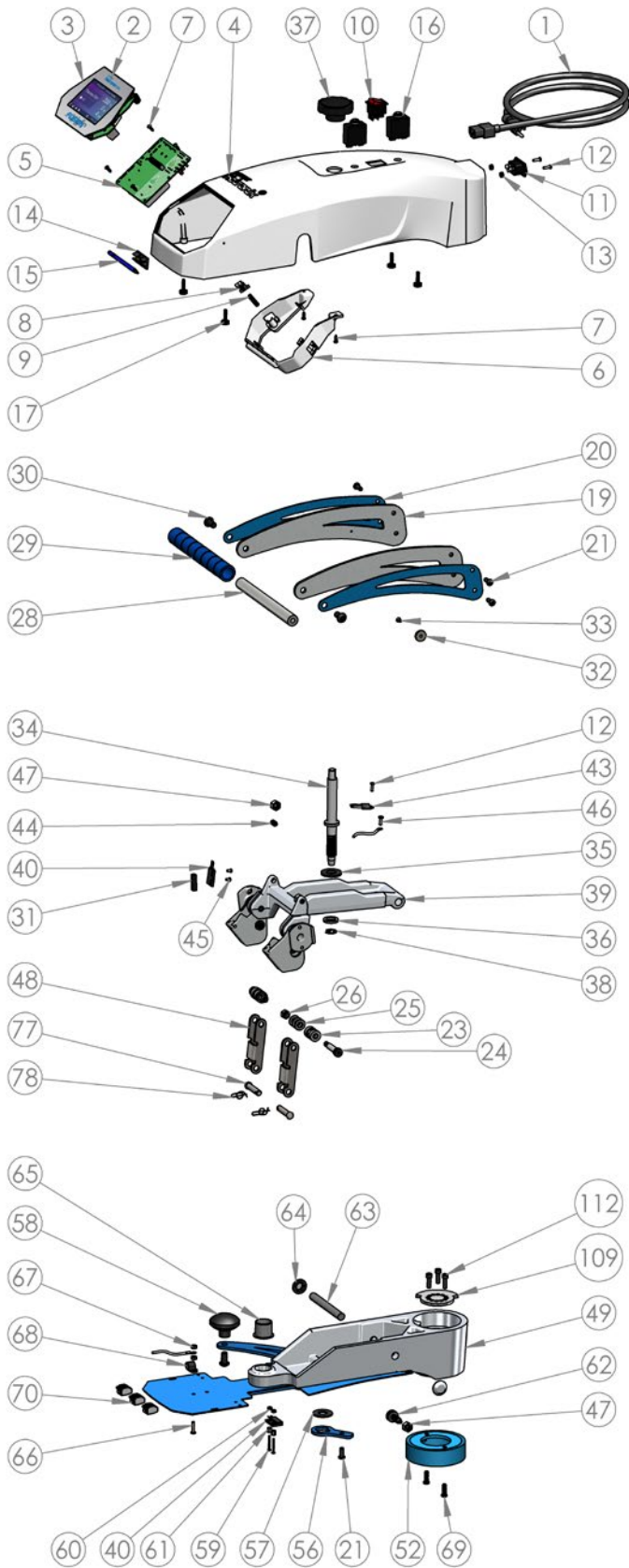

CONTACT US

STAHL'S Hotronix®

One Industrial Park
Carmichaels, PA 15320
U.S.A.

Technical Support

hotronix.com/support

Customer Service

customerservice@hotronix.com

Replacement Parts

800.727.8520
8AM - 7PM EST

Web

hotronix.com

